

PMV300

UNIVERSAL PROJECTOR CEILING MOUNT

4 FIXING POINTS

The reliable and robustly crafted PMV300 projector mount is the basis for any properly made audiovisual installation. The handle is characterized by a load capacity adapted to the weight of the device and protection against accidental falling out. It ensures that the projector is positioned in relation to the projection screen, so that the displayed image is of the best quality. The handle is characterized by precise and convenient adjustment of the distance to the ceiling and the possibility of hiding the wiring through the integrated cable management system. An indisputable advantage of the handle is modern design and aesthetics of workmanship, thanks to which it works great in the most prestigious interiors.

FEATURES

- Modern Design with a high-end finish
- Aluminum construction with a semi-textured powder coat or anodized finish
- Ceiling plate covers to hide fixings included
- Micro-Adjustment mechanism ensures precise installation
- Universal for all key projectors with multiple fixing points
- Distance from ceiling to projector from 1000 mm to 1700 mm
- Internal cable management in tube
- 50° horizontal adjustment

PRODUCT SPECIFICATIONS

Short index	PMV300
Product group	Projector Mounts
Category	Projector Ceiling Mounts
Colour	Black
Warranty	Limited 5-years
Maximum load	30 kg
Forward tilting	-7,5°/+7,5°
Height adjustment	Yes

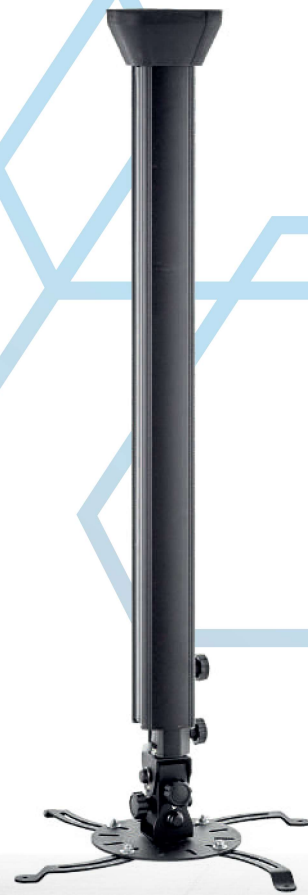

30 kg



-7,5°/+7,5°



1000-1700



-25°/+25°



4 mounting holes



Internal cable management in tube

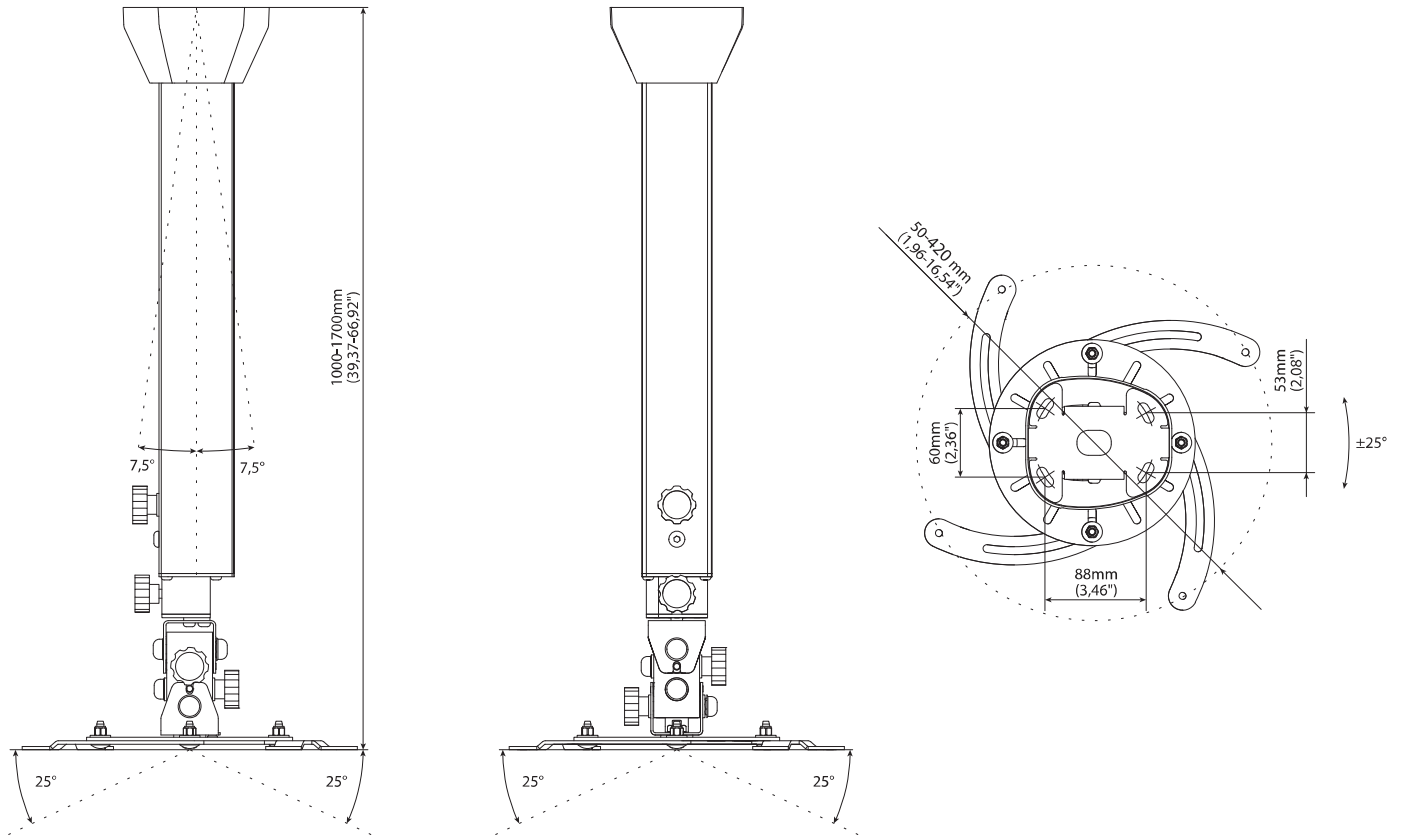

Height adjustment

TECHNICAL SPECIFICATIONS

Product dimensions	W: 180 mm D: 180 mm H: 1000 mm (W:7,08" D:7,08" H:39,37")
Product weight	6 kg (13,22 lb)
Max. distance from mounting surface	1700 mm (66,92")
Min. distance from mounting surface	1000 mm (39,37")
Max. mounting pattern	420 mm (16,54")
Min. mounting pattern	50 mm (1,96")

LOGISTICS DATA

SAP INDEX	EAN CODE	COLOUR	PACKAGE DIMENSIONS	PACKAGE WEIGHT
WUSU-PMV300	5902841112131	BLACK	990 x 210 x 160 mm 38,97 x 8,26 x 6,29"	6,4 kg 14,10 lb

HS Code (Harmonized System): 732690, HTS Code (Harmonized Tariff Schedule): 7326909890, Country of Origin: Poland

ACCESSORIES AND RELATED PRODUCTS

PMV100



PMV200

2022 - EDBAK Sp. z o.o. All rights reserved.
 The information included in the specifications reflects the current technical specifications at the time of printing. We reserve the right to modify technical or physical specifications without prior notice. EDBAK name and EDBAK logo are registered trademarks of EDBAK Sp. z o.o. All EDBAK images and symbols are sole property of EDBAK Sp. z o.o. Edbak shall not be held liable for any loss or damage caused by incorrect installation or mounting. Copying this specification in whole or in part is only allowed after obtaining written consent from EDBAK Sp. z o.o.
 PMV200-211001-EN